

ROOF MAKER

WORLD CLASS ROOFLIGHTS



PRODUCT SPECIFICATION AND INSTALLATION GUIDE

OPENING LUXLITE™ (WITH BLACKOUT BLINDS)

OPENING LUXLITE™ WITH BLACKOUT BLINDS: PRODUCT SPECIFICATION AND INSTALLATION GUIDE

CONTENTS

- **PAGE 2** PRODUCT SPECIFICATION CROSS SECTION DRAWING
- **PAGE 3** OPENING SIZE GUIDE *(guidelines on how far your Luxlite™ will open, dependant on the height/depth of the rooflight)*
- **PAGES 4-8** STEP BY STEP INSTALLATION GUIDE
- **PAGE 9** ROOF CROSS SECTION FITTING GUIDE
- **PAGES 10-11** ROOFLIGHT WIRING GUIDE-ROCKER SWITCH OPERATION
- **PAGES 12-13** CABLE LOCATION GUIDE FOR REMOTE CONTROLLED ROOFLIGHTS WITH RAIN SENSOR *(guidelines on where to store the control box and where to fix the rain sensor externally with the provided bracket)*
- **PAGES 14-15** ROOFLIGHT WIRING GUIDE-REMOTE CONTROL OPERATION WITH RAIN SENSOR
- **PAGE 16** BLACKOUT BLIND CORD CONFIGURATION GUIDE *(outlines how many support cords will be visible on your blackout blinds)*
- **PAGES 17-22** CONNECTING YOUR REMOTE-CONTROLLED BLACKOUT BLIND *(wiring guide for your blackout blinds)*

OPENING LUXLITE™: STANDARD PRODUCT SPECIFICATION

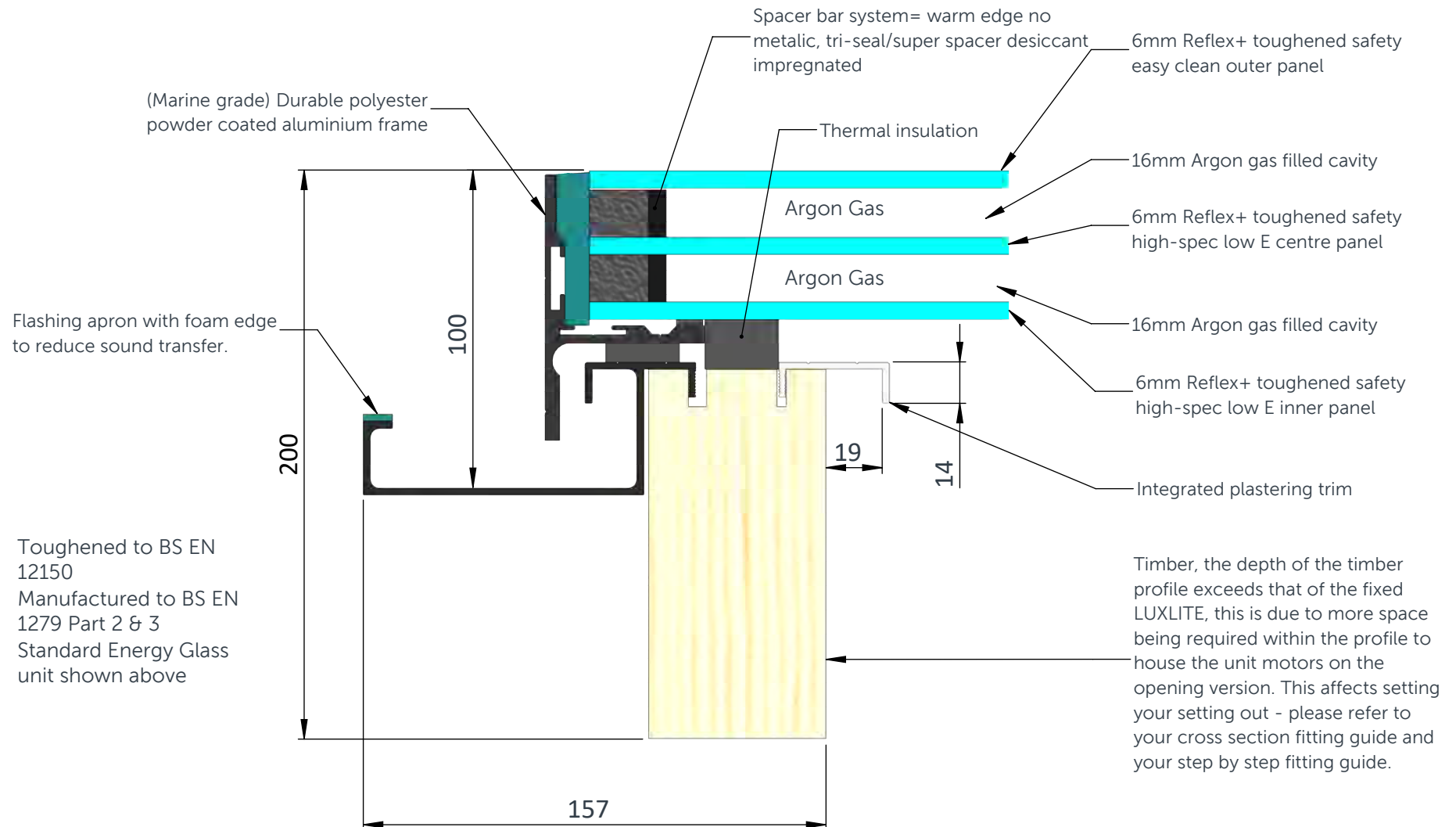

OPENING SIZE GUIDE FOR THE HINGED OPENING LUXLITE™

The maximum opening capacity of your Hinged Opening Luxlite™ will depend on the size of the rooflight you have ordered. The potential opening size ranges from 200mm to 400mm.

The chart below illustrates the maximum achievable opening size dependent on the height (or depth) of your rooflight.

Luxlite™ rooflights will be top hung with the hinges located along the top of the rooflight, and the opening located at the bottom of the rooflight. It is the distance running from top to bottom of the rooflight which we refer to as the internal height or depth. The stroke length refers to the length of the chain and in turn, the size of the opening that will be achieved when fully open.

Internal height of rooflight (depth)	Stroke length (opening size at widest point)
700mm +	400mm
699mm - 600mm	300mm
599mm - 500mm	250mm
499mm - 400mm	200mm

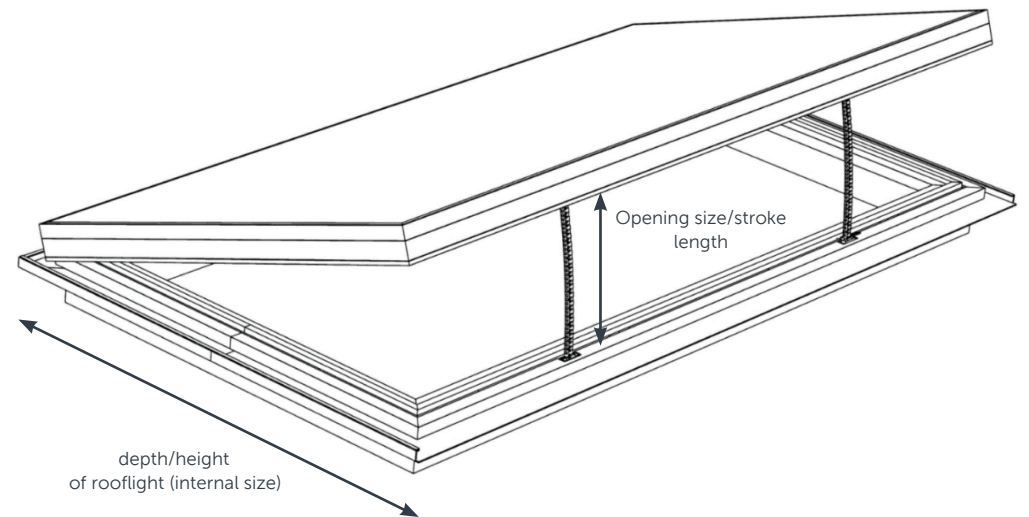

OPENING LUXLITE™: INSTALLATION INSTRUCTIONS

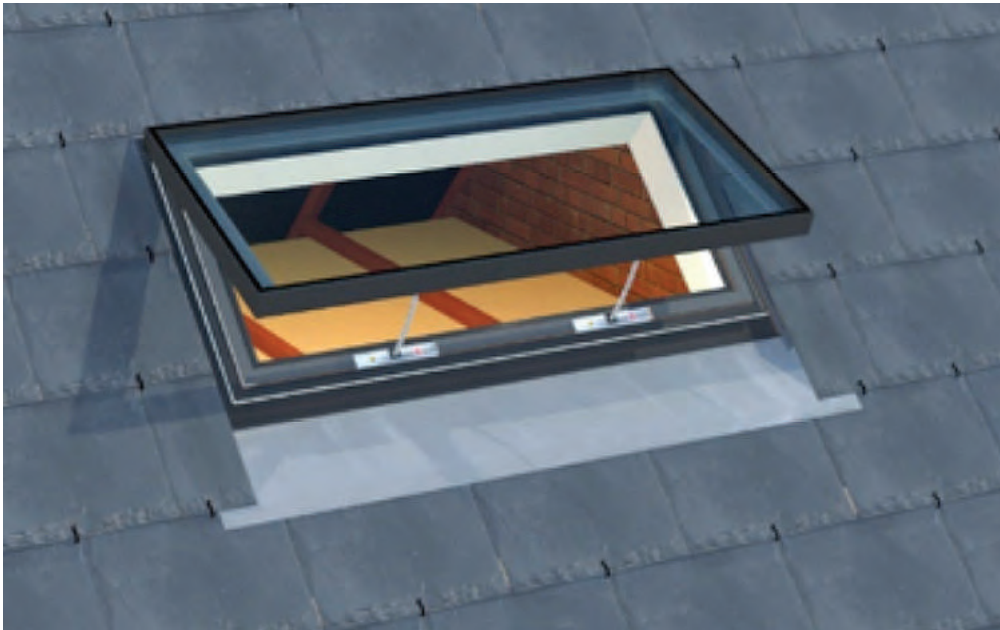

INSTALLATION GUIDE

Make sure to read through all steps and understand all requirements before beginning assembly.

In addition to your Luxlite® you will need:

- Silicone Adhesive Sealant (high quality; Dow Corning 791 suggested)
- Drill, bits and screws as required

Please take precaution when moving heavy objects and working at height; be sure to use correct equipment.

GUIDE WEIGHTS

Size (mm)	Weight (kg)
400x400	37
600x600	56
900x700	78
1400x700	108
1000x1000	107
1500x1000	143
2000x1000	144
2400x1000	168
3000x1000	201
1500x1200	164
2000x1200	164
2400x1200	189

PLEASE NOTE - weights stated can vary and work to a +/- 10% tolerance. We can provide weights for sizes not listed.

ROOF MAKER

WORLD CLASS ROOFLIGHTS

Call us: 0116 269 6297
Mon-Fri 9-5pm

STEP ONE

FIT TRIMMERS TO YOUR JOISTS

The internal dimensions of the aperture created by your trimmers and joists should be 130mm wider than the Luxlite™ you ordered. (e.g. for 2000x1000mm Luxlite™, the internal dimensions of your aperture should be 2130x1130mm). See the cross section fitting guide at the end of this document for more detail.

Fit trimmers across the joists adjacent to the aperture, and a beam across the trimmers, as shown. These additional structural members will support the tile battens around the rooflight.



STEP TWO

FIT UNDERFELT TO YOUR ROOF

Fit underfelt to your roof. This should extend to the rim of the aperture where your Luxlite™ will be installed. Seal the underfelt to the timber around the aperture.

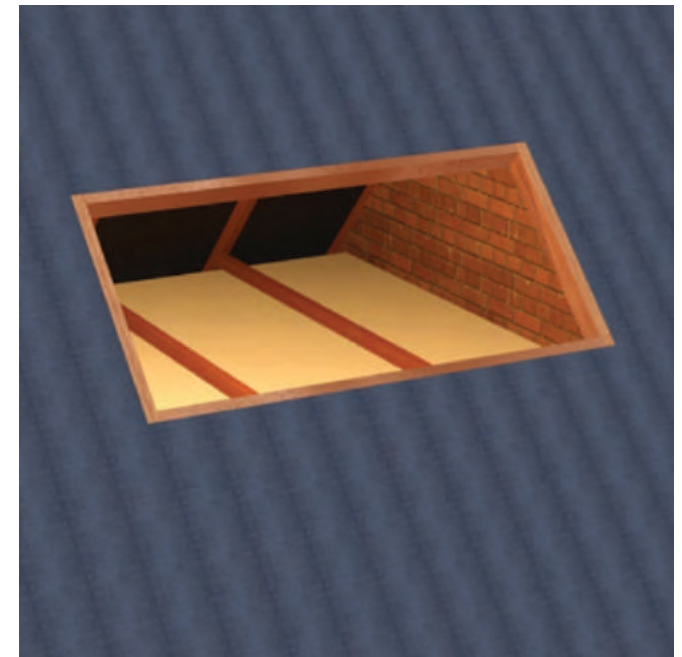

ROOF MAKER

WORLD CLASS ROOFLIGHTS

Call us: 0116 269 6297
Mon-Fri 9-5pm

STEP THREE

PREPARE AND FIT A TIMBER WEDGE BELOW THE APERTURE

The bottom of the wedge should meet level with the tiles that will be installed later. This can be determined by trial fitting the Luxlite™ assembly.

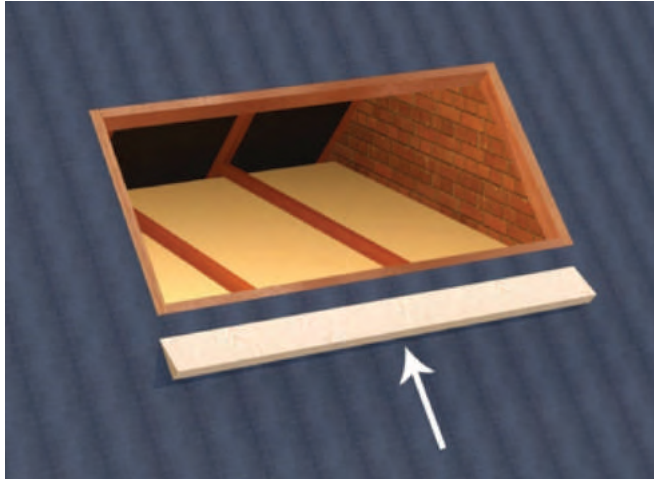

STEP FOUR

COVER THE WEDGE WITH FLASHING

Cover the wedge installed in the previous step with flashing (flashing and wedge not provided).

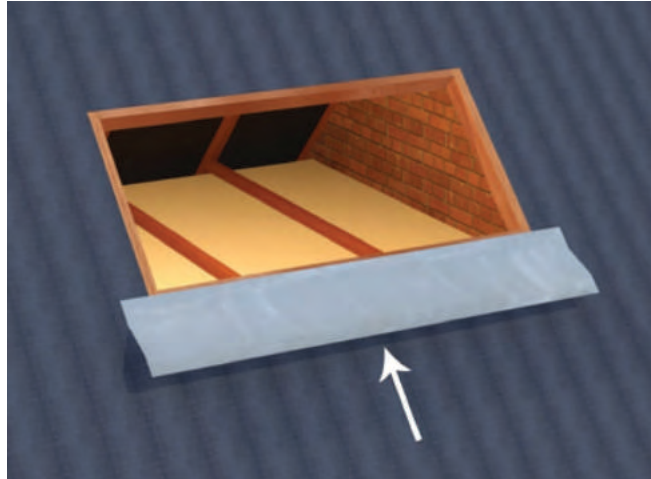

STEP FIVE

BRING YOUR LUXLITE™ INTO POSITION

Bring your Luxlite™ into position and align it so that it is centred on your aperture.

Seal the interface between the Luxlite™ and the aperture with silicone.

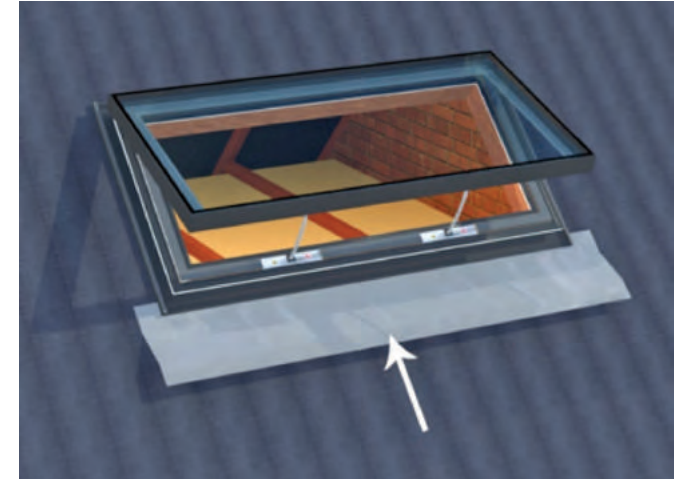

ROOF MAKER

WORLD CLASS ROOFLIGHTS

Call us: 0116 269 6297
Mon-Fri 9-5pm

STEP SIX

FIX YOUR LUXLITE™ TO THE ROOF

Fix your Luxlite™ to your roof. Refer to the assembly section view in the appendix at the end of this document for more detail.

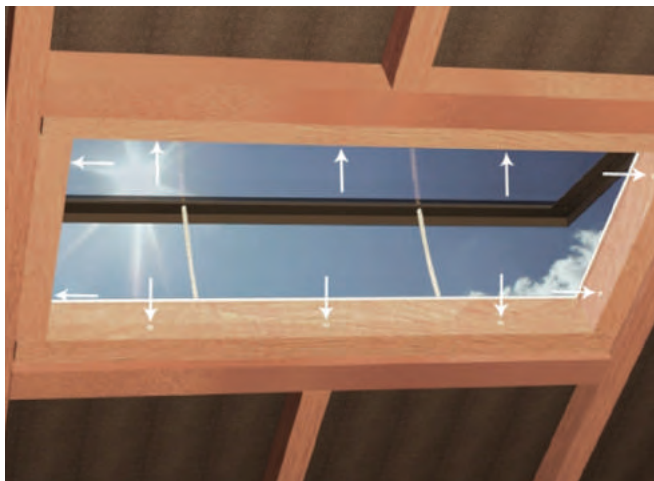

STEP SEVEN

FIT BATTENS TO THE ROOF

Tile battens can now be fitted to your roof. The battens should be flush with the edge of the Luxlite™ aluminium apron.

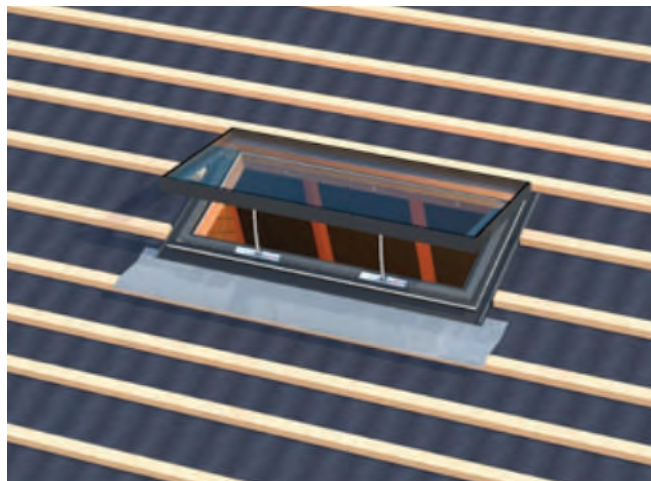

STEP EIGHT

FIT FLASHING TO COVER THE BATTENS

Seal beneath the lip of the apron, drape over battens. Tiles will sit over this flashing. (Note: side flashing is only required when using pantiles).

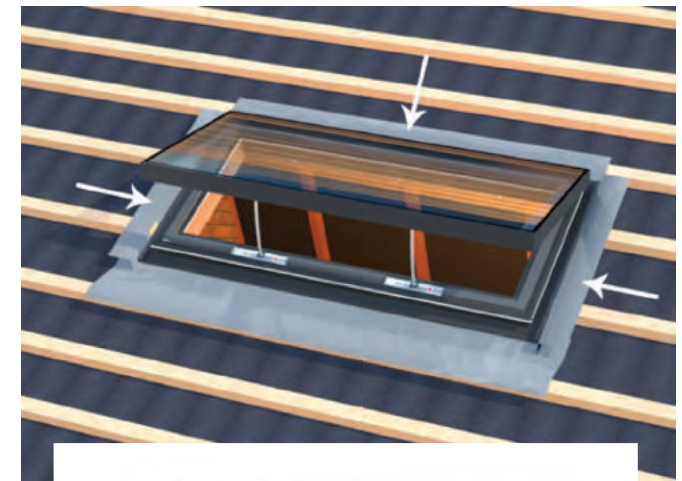

ROOF MAKER

WORLD CLASS ROOFLIGHTS

Call us: 0116 269 6297
Mon-Fri 9-5pm

STEP NINE

FIT TILES TO THE ROOF

You are now free to fit tiles to your roof. The Luxlite™ has been designed so that your roof tiles can overlap the apron, leaving little aluminium exposed for a minimalistic aesthetic.

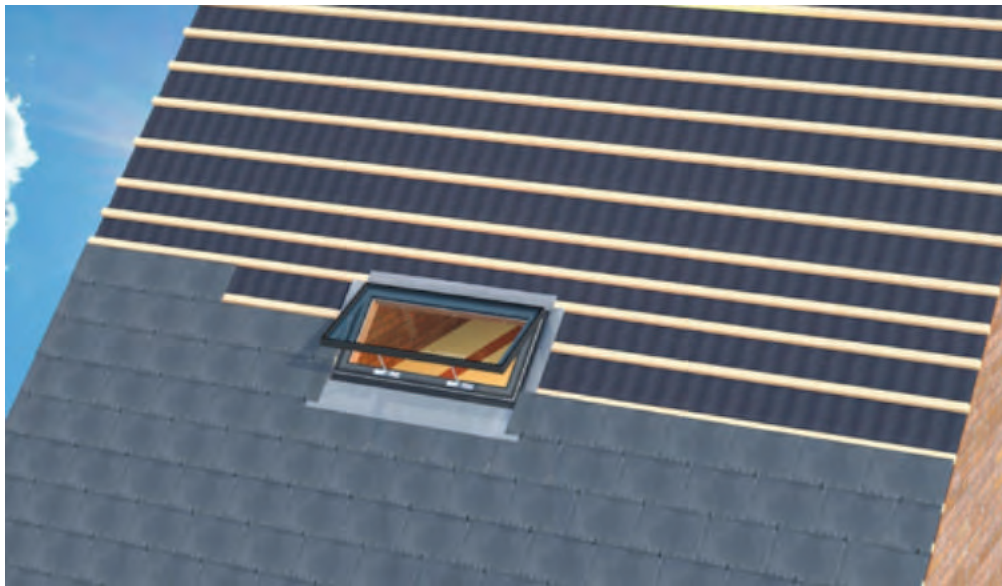

STEP TEN

PLASTERBOARD TO FINISH ASSEMBLY

Apply plasterboard to the internal faces of your aperture. The plasterboard is to be applied up to the internal trim of the Luxlite™ (for plastering finish guidelines, please follow the cross section fitting guide, included at the end of this document).

Congratulations! Your Opening Luxlite™ is now fully installed.

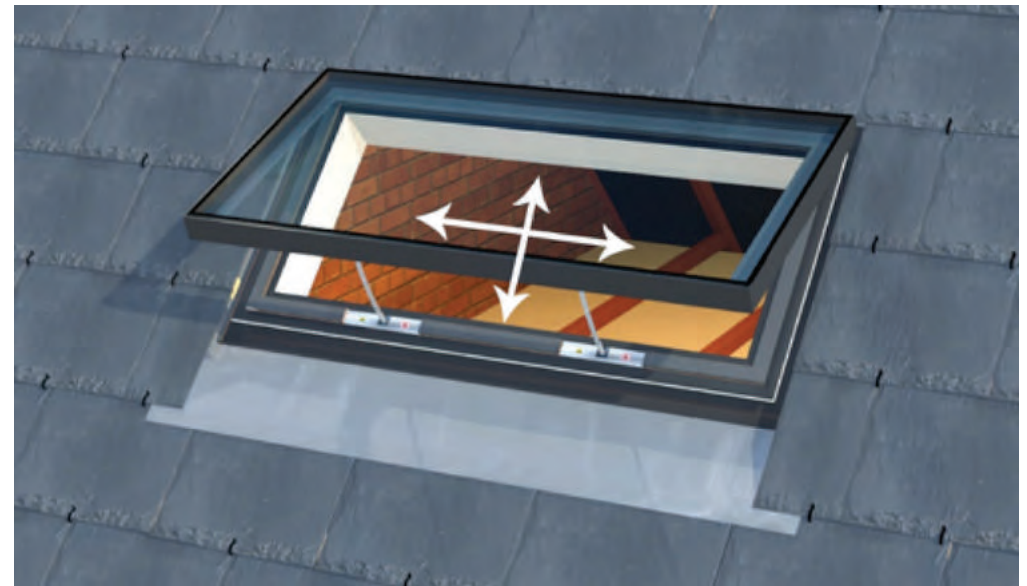

ROOF MAKER

WORLD CLASS ROOFLIGHTS

Call us: 0116 269 6297
Mon-Fri 9-5pm

ROOF SECTION FITTING GUIDE

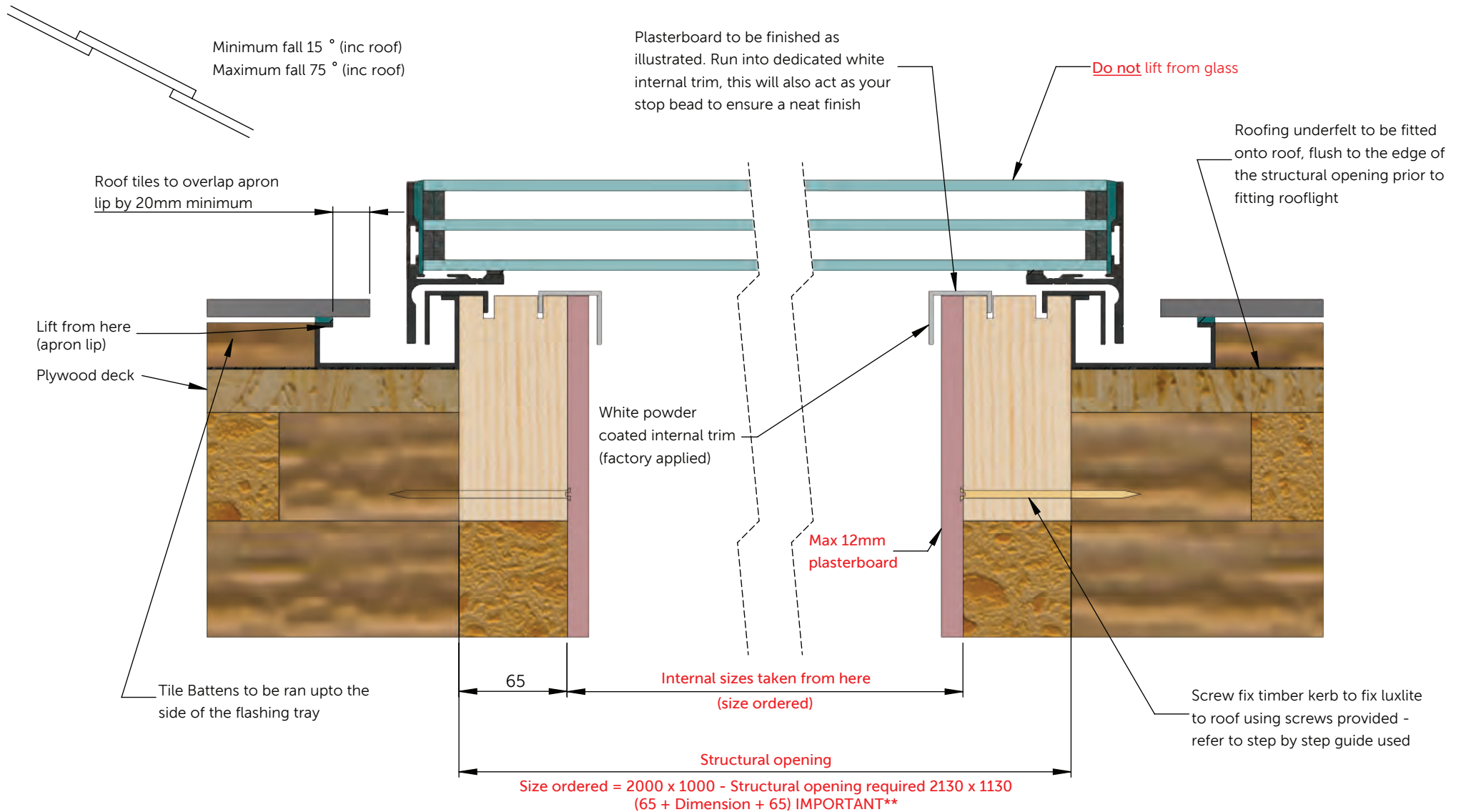

ROCKER SWITCH WIRING DIAGRAMS (3 CORE)

NOTE: THE TYPE OF MOTOR YOU RECEIVE IS JUSTIFIED BY THE SIZE OF THE ROOFLIGHT ORDERED.

3 core - single motor

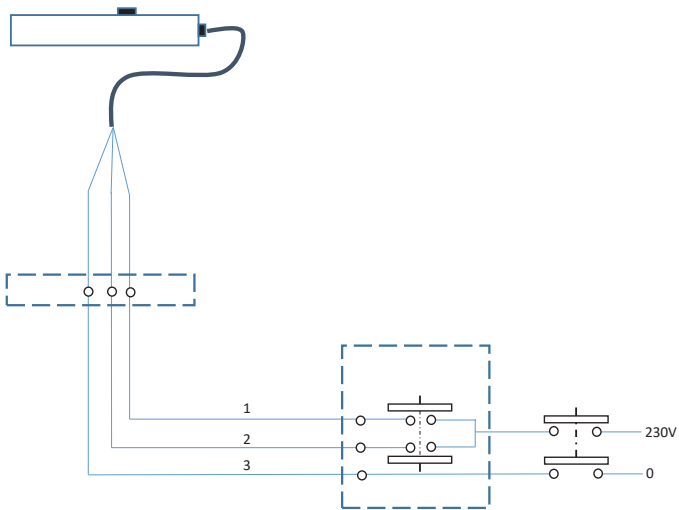

3 core - multiple motors

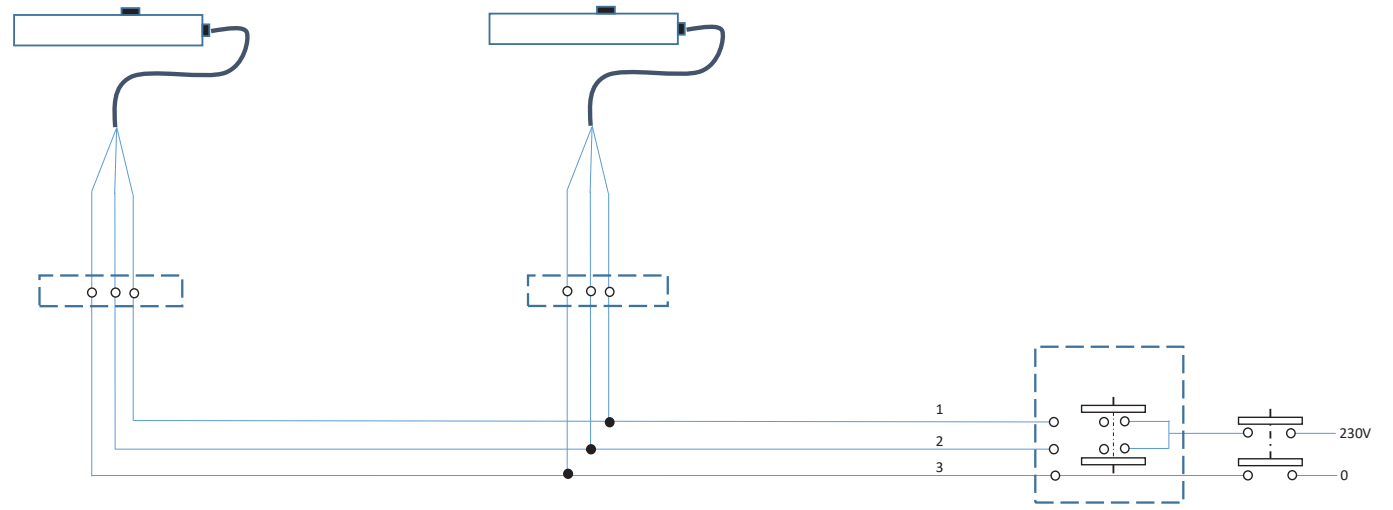

Colour	Number	Signal
Brown	1	Opens
Black	2	Closes
Grey	3	Neutral

Refers to both single and multiple motors.

ROCKER SWITCH WIRING DIAGRAMS (4 CORE)

NOTE: THE TYPE OF MOTOR YOU RECEIVE IS JUSTIFIED BY THE SIZE OF THE ROOFLIGHT ORDERED.

4 core - single motor

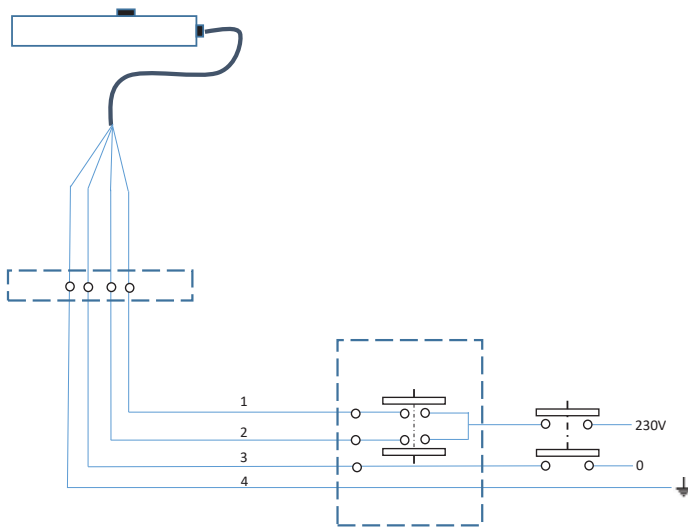

4 core - multiple motors

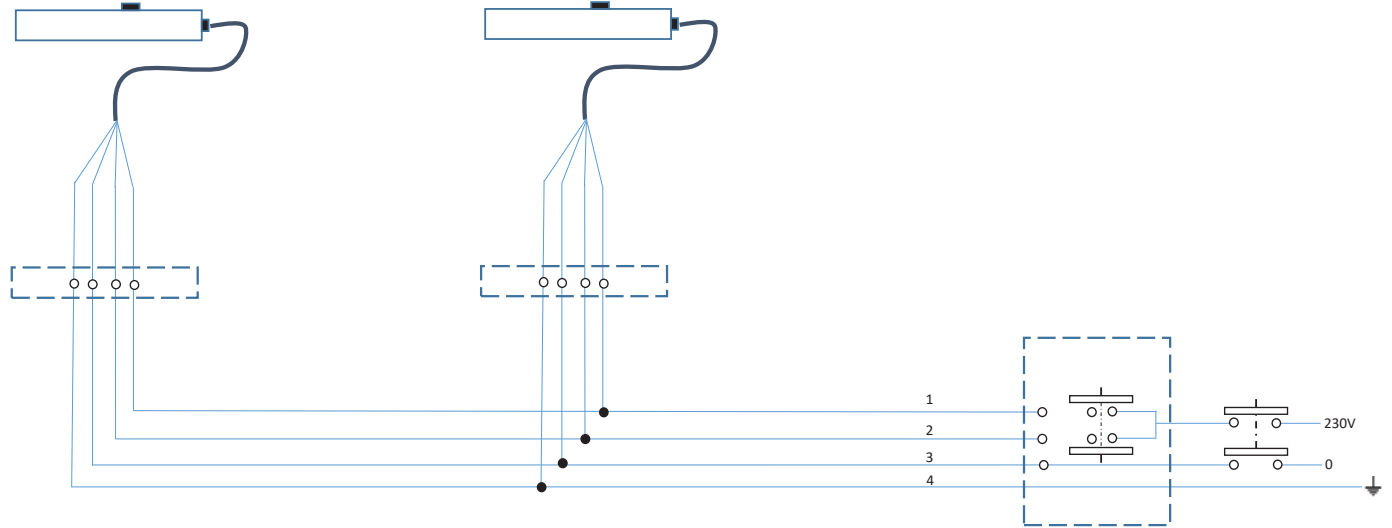

Colour	Number	Signal
Brown	1	Opens
Black	2	Closes
Blue	3	Neutral
Yellow/Green	4	Ground

Refers to both single and multiple motors.

REMOTE CONTROLLED HINGED OPENING LUXLITE® – CABLE LOCATION GUIDELINES (not to scale)

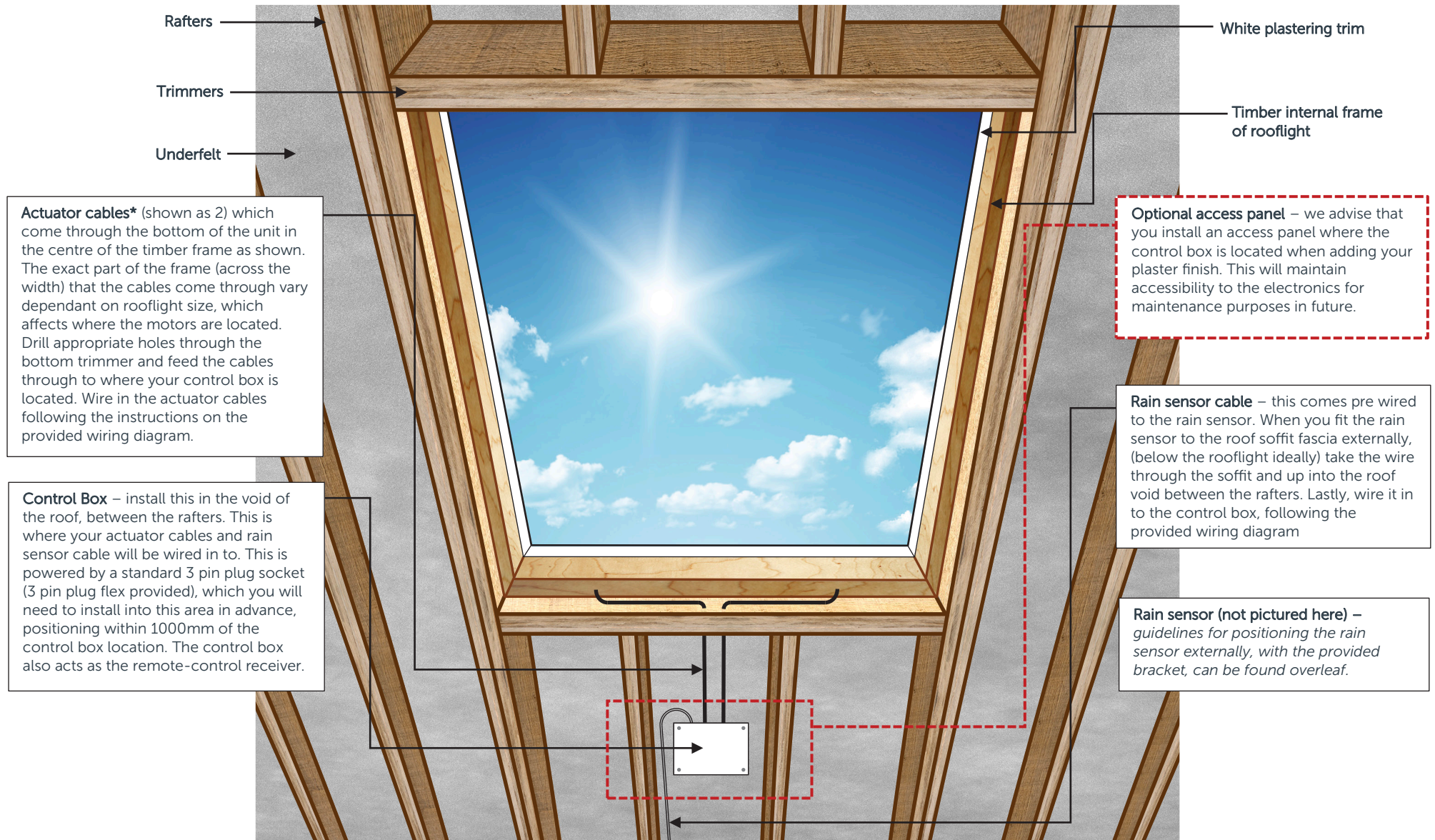

REMOTE CONTROLLED HINGED OPENING LUXLITE® – CABLE LOCATION GUIDELINES (not to scale)

The below diagram shows a roof section of the roof Soffit Fascia, which is the location that you should position the rain sensor for your Luxlite®

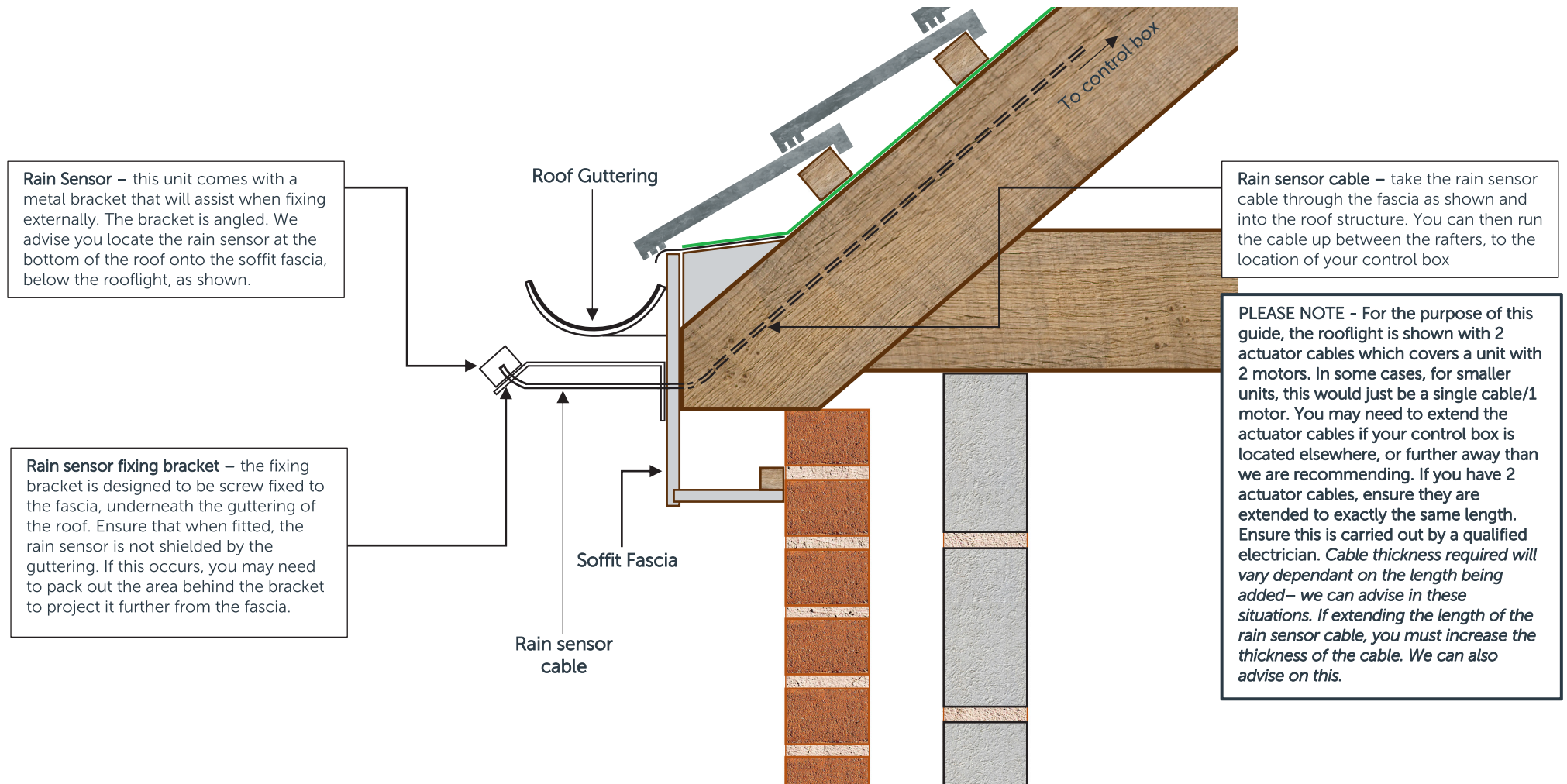

REMOTE CONTROLLED ROOFLIGHT WIRING GUIDE

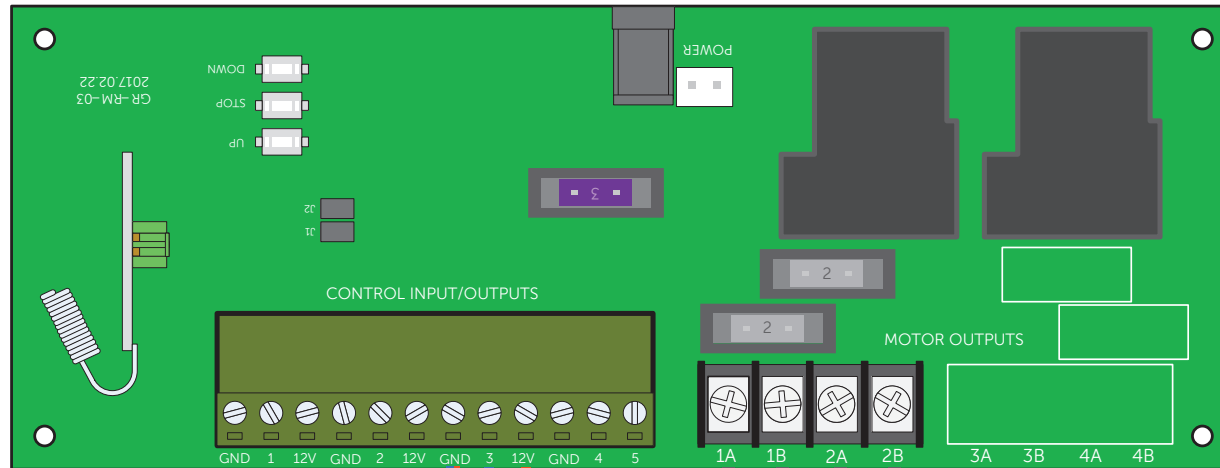

Control Input/Outputs Key

GND: Ground (-ve)

12V: +12V DC regulated supply

- 1: Safety Switch Signal Input
Connect to any ground, GND, to stop/switch off the output
- 2: Thermostat Signal Input
Connect to any ground, GND, to switch output to 'down'
- 3: Rain Sensor Signal Input
Connect to any ground, GND, to switch output to 'down'
- 4: Control up
Connect via switch any ground, GND, to switch output to 'UP'
- 5: Control down
Connect via switch any ground, GND, to switch output to 'DOWN'

Kemo Rain Sensor

Connect:

Orange to any "12V"

Blue to "3"

Orange - White to any "GND"

Blue - White also to any "GND"

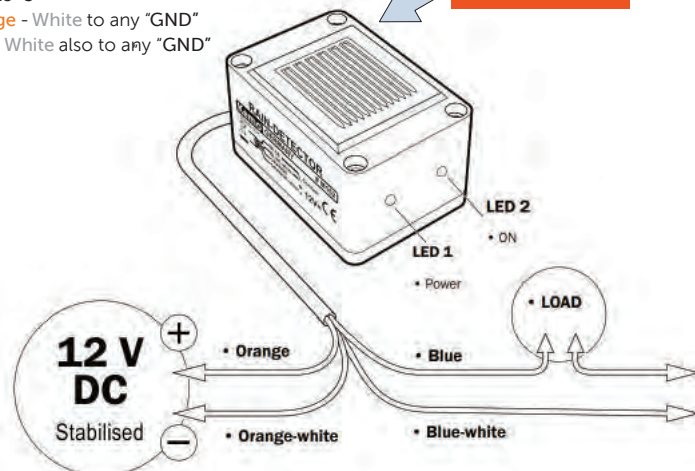



Outputs to actuator(s). If only using one actuator then either of the output pairs 1A and 1B or 2A and 2B can be used. Each numbered output is individually fused and is capable of supplying up to 2.1A continuous at 24VDC. The polarity at each output inverts when swapping between 'up' and 'down'. Outputs 3 and 4 are not used (cables here shown as grey – please see overleaf, which shows where cables need to be wired into the output pairs, which is dependent on the type of rooflight being installed).

WARNING

Ensure that the combined load at the three "12V" output terminals does not exceed 1A. A single Kemo rain sensor should consume less than 0.2A, so if using a rain sensor there should be a further 0.8A available at 12VDC (~9W) to also operate thermostats, safety sensor switches and similar devices. DO NOT connect any 12V directly to any GND, or any of 1, 2, 3, 4, 5 to any 12V

REMOTE CONTROLLED ROOFLIGHT WIRING GUIDE

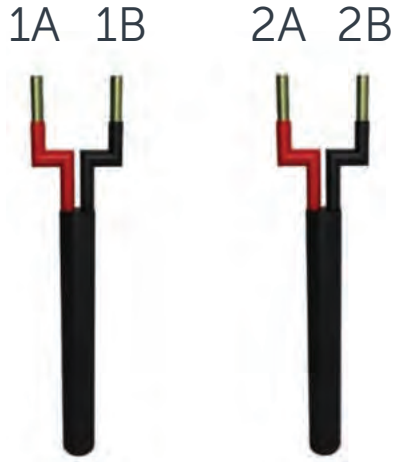
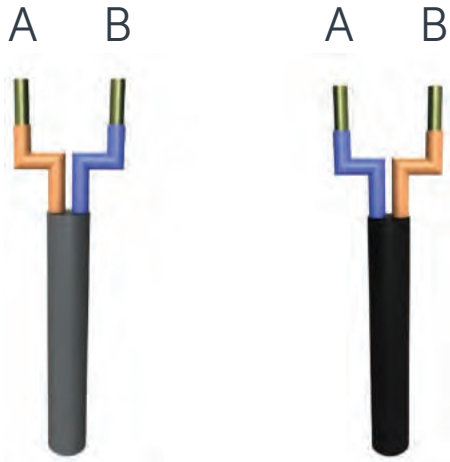

The chart below shows the different wiring combinations you will be working with, dependant on the type of rooflight you are installing. This is specified below each variation of wire shown. Open-Lite has been shown as 2 cables which will always be the case. For sliding rooflights, there will always be 2 cables that you will wire in to output pairs 1A-1B & 2A-2B. For Flat hinged opening and Luxlite hinged opening rooflights, you will either have 1 set or 2 sets of actuator cables dependant on the amount of motors that your rooflight has been allocated. For single motor units, you can use either 1A-1B or 2A-2B and for 2 motors you will use both output pairings.

 <p>1A 1B 2A 2B</p>	 <p>A B A B</p> <p>If actuator cabling is grey If actuator cabling is black</p>	 <p>1A 1B 2A 2B</p> <p>*Communication wires to be connected to each other. All other wires not illustrated above are not required</p>
<p>All Sliding rooflights</p>	<p>Flat Hinged Opening & Luxlite Hinged Opening</p>	<p>Open-Lite (roof access)</p>

BLACKOUT BLIND CORD CONFIGURATION GUIDE

REFERENCE: PROPOSED CORD & NYLON CONFIGURATION PER ROOF BLIND

KEY:

-  Spooling cord – this cord travels through the central section of the fabric. Cords are paired together as an 'extend & return' system. Cord pairs are spaced 20mm apart. Spooling cords are visible when the blind fabric is compressed closed.
-  Support nylon – this semi-transparent nylon cord is fitted to provide fabric support. Nylon cords are visible when the blind fabric is compressed closed.

Motor position is defined as looking at the underside of the headrail where the motor and cord spooling componentry are exposed.



THIS SET UP APPLIES TO ALL ROOF BLINDS 500MM TO 699MM WIDE



THIS SET UP APPLIES TO ALL ROOF BLINDS 700MM TO 1100MM WIDE

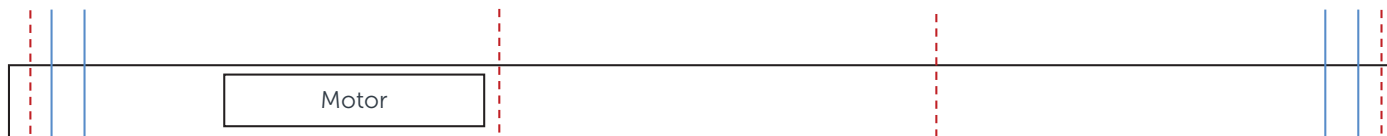

THIS SET UP APPLIES TO ALL ROOF BLINDS >1100MM TO 1400MM WIDE



THIS SET UP APPLIES TO ALL ROOF BLINDS >1400MM TO 2000MM WIDE

CONNECTING YOUR REMOTE-CONTROLLED BLACKOUT BLIND



INTRODUCTION

Thank you for purchasing a blackout blind with your new rooflight. This guide will explain how to install your remote-controlled blackout blind.

WHAT COMES WITH MY BLACKOUT BLIND?

- Blind and motor housing (factory fitted to your rooflight)
- White perimeter blind trim (factory fitted to your rooflight)
- 1 x 2400mm extension cable (factory fitted to your rooflight)
- 1 x boxed, Somfy remote-control. This will be given to you when your rooflight is delivered.
- 1 x boxed, Somfy 3 pin power adapter with 3000mm cable. This will be given to you when your rooflight is delivered.



STEP ONE

PREPARATION IS REQUIRED IN THE CEILING VOID OF THE ROOM BELOW YOUR ROOFLIGHT IN ORDER TO PROVIDE A POWER SOURCE TO YOUR BLIND. THIS GUIDE COVERS EACH STEP REQUIRED TO COMPLETE THE SET-UP.

The blackout blind is factory fitted to your rooflight and will be in place when you take delivery of your unit. On the inside of your rooflight, you will see a white surround trim, fitted to the internal perimeter of the built-in upstand/frame. When the blind is fully retracted the blind motor housing will be clearly visible at one end. You will also see guide cables extending from one side to the other. These run the length of the rooflight, with the number and arrangement varying dependent on the size of the blind.

When positioning your rooflight, be careful not to catch these cables or pull them with any force..

ILLUSTRATION SHOWING THE UNDERSIDE OF A LUXLITE™ ROOFLIGHT WITH A BLIND

Motor housing

Located at the end where your blind folds back.

Power cable

The electric cable will be located at the same end as the motor housing.

Guide cables

Quantity and arrangement will be dependent on the size of your unit.

White perimeter blind trim.

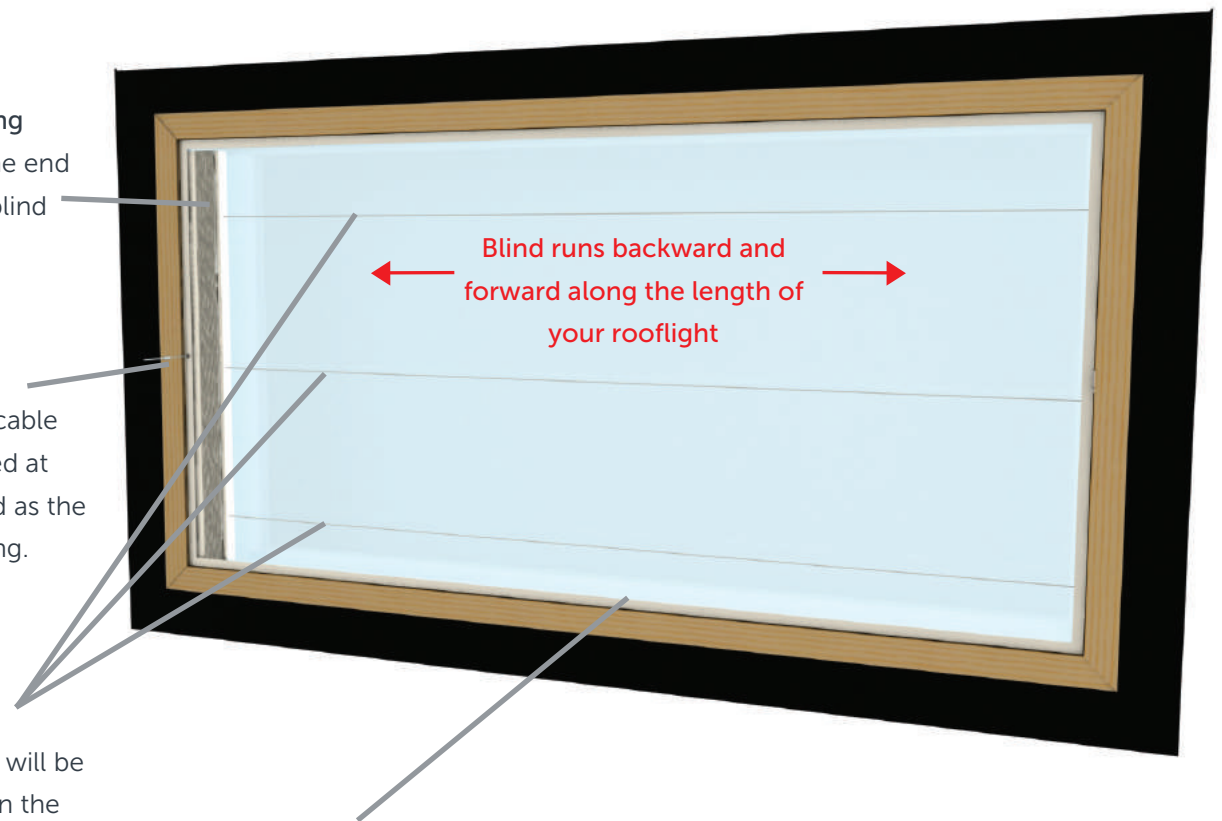

STEP TWO

TO POWER THE BLINDS.

A standard 3 pin plug needs to be located in your ceiling void area, within 4000mm of the blind motor.

We recommend creating an access panel so you can easily reach the installed electronics at a later date if required.

We advise that you do not plaster the ceiling in the room below until the rooflight is fitted and the blinds have been wired in. This will provide a clear area to work, allowing you to make last minute adjustments and avoid the blind cables being stretched unnecessarily if you need to achieve more slack.

The blind will move forwards and backwards as the arrows indicate.

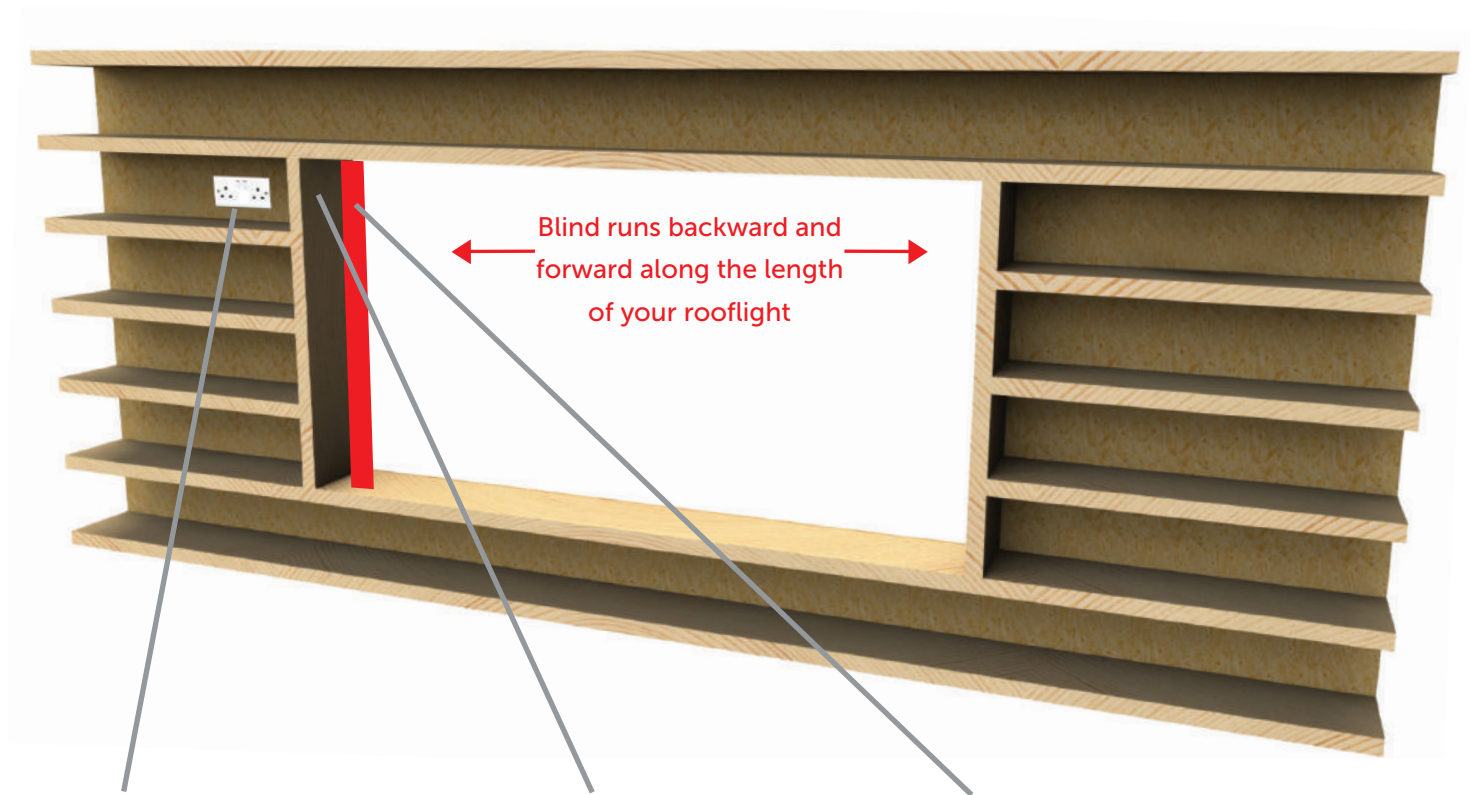

Situate the plug socket within 4000mm of the blind motor.

Create an access panel, so you can reach the electronics post installation.

Location of blind motor when installed.

STEP THREE

YOU ARE NOW READY TO INSTALL YOUR ROOFLIGHT.

Once your rooflight has been installed, you will be ready to connect your blinds to your power source. You will see the coiled electrical cabling below your blind motor housing. The cable feeds through a pre-drilled hole in the white perimeter blind trim, up to the blind motor. This is the 2400mm extension cable. Unwind the cable, ensuring you do not allow the connection in the wiring to be pulled out of the hole.

Run the cable straight down the reveal.

WARNING: You must visibly mark where you have run the wire, to avoid damaging the cable with screws or nails when you fix the plasterboard.

Once you have run the cable up to the joist/rafter, drill a hole through the joist/rafter so you can run the cable into the ceiling void, where you have positioned your 3 pin plug.

THE WIRE CONNECTION MUST STAY ABOVE THE PERIMETER TRIM AS YOU MAY NEED TO LOCATE IT AT A LATER DATE.

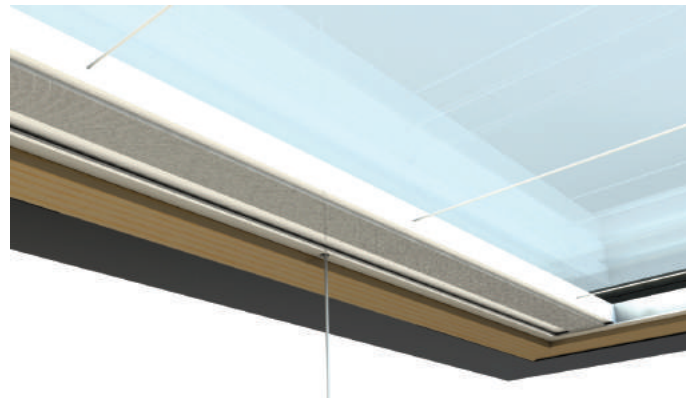

Cable coming through trim, no connection visible.

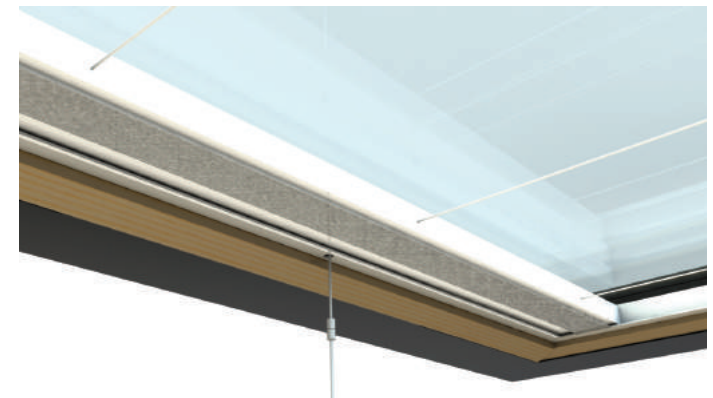

Cable coming through trim with connection visible.

STEP FOUR

CHANNEL INTO YOUR TIMBER.

You now need to notch a channel into your timber reveal, which will run the length from the hole you have just drilled to the hole where the cable comes through, in the white perimeter blind trim. Running the wire in this channel will ensure your plasterboard can fit flush to the timber. Please ensure the power source is located within 4000mm of where your blind motor will be positioned.

When you have run the cable from your blind into the ceiling void area, through the drilled hole, take the 3000mm power adapter cable provided and connect the 2 cables together. This is a small male/female 'push and click' connection.

Next, plug in the adapter to your 3 pin plug socket that you have located in the ceiling void. Your remote-controlled blackout blind is now connected.

The Somfy remote-control provided with your blind has been synchronised in the factory, so will work as soon as the blind is connected.

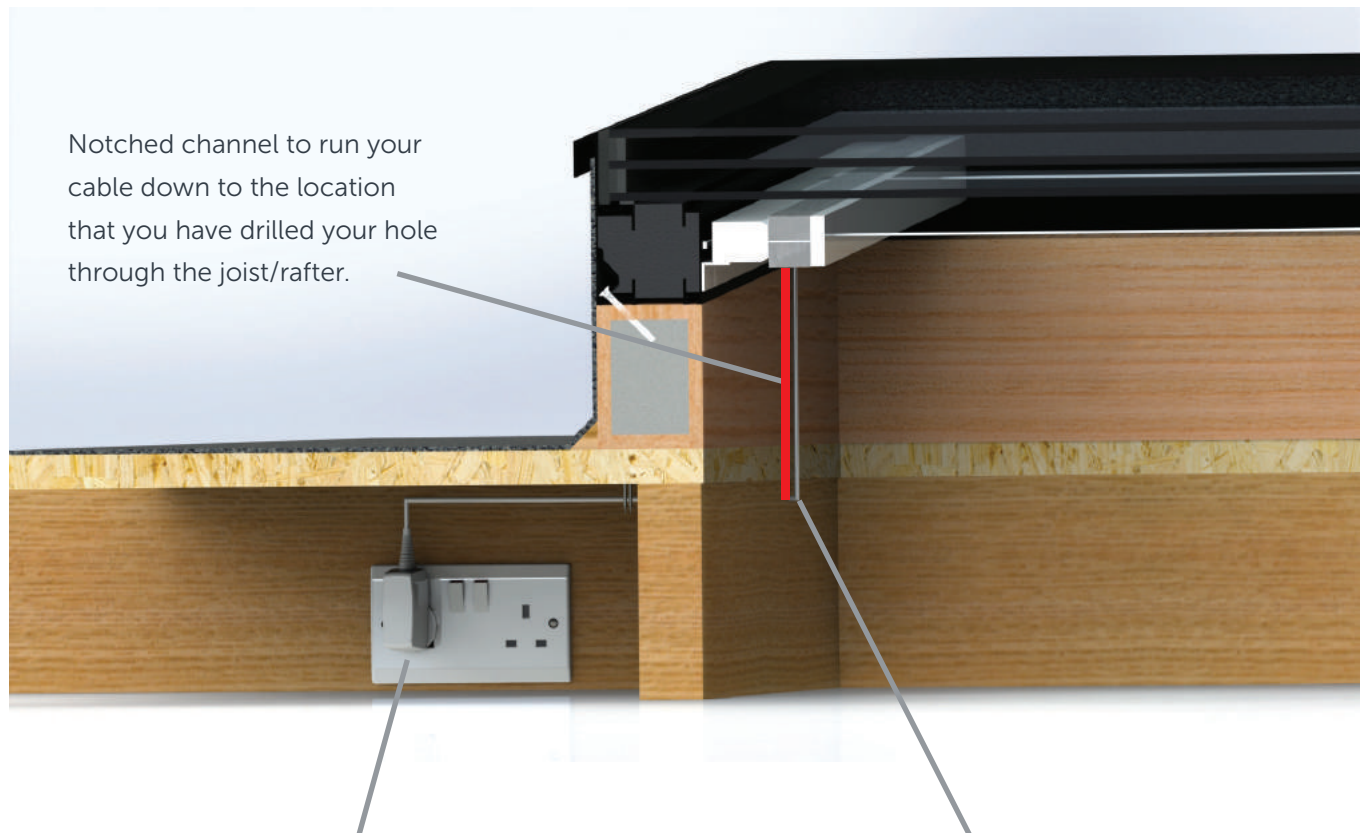

Notched channel to run your cable down to the location that you have drilled your hole through the joist/rafter.

Once you have fed the cable through to the void area in your ceiling, connect it to the 3000mm plug adapter cable provided.

Hole in your joist/rafter to feed your cable through to where you have located your 3 pin plug.

STEP FIVE

PLASTERING. PLEASE ENSURE YOUR BLIND IS FULLY OPERATIONAL BEFORE PLASTERING.

Plaster the ceiling in the room below and the reveals that lead up to the rooflight. The white perimeter blind trim gives you a perfect surface to plasterboard and wet plaster into.

We advise that you cover the retracted blind and motor housing with low adhesive masking tape or equivalent, to prevent you soiling the blinds when applying your wet plaster.

At this stage, you can incorporate an access panel into your ceiling or reveal leading up to the rooflight as mentioned previously.

YOUR BLIND INSTALLATION IS NOW COMPLETE. WE HOPE YOU ENJOY YOUR NEW ROOFLIGHT WITH BLACKOUT BLINDS



When you have plastered your reveals leading up to the rooflight, you have the option of installing an access panel in this area.